

SLD Relocatable Lighting Tower Remote Instructions



Important Safety Instructions

SAVE THESE INSTRUCTIONS:

This manual contains important safety, installation, and operating instructions for the Remote Meter.

General safety information

- Please inspect the MT50 thoroughly after it is delivered. If any damage is seen, please notify the shipping company or our company immediately. A photo of the damage may be helpful.
- Read all instructions and cautions in the manual before starting the installation.
- Keep the MT50 away from rain, exposure, severe dust, vibrations, corrosive gas, and intense electromagnetic interference.
- Do not allow water to enter the remote meter.

 WARNING	Do not install this product in humid, salt spray, corrosion, greasy, flammable, explosive, dust accumulative, or other severe environments.
---	---

There are no user-serviceable General Information

Features

The MT50 remote meter, using the controllers designed with RS485 communication, can monitor the controller's real-time working status and program the parameters.

- Easy to install and operate.
- Real-time display of fault alarms
- Locally reading of real-time parameters
- Powered by the controller directly.
- Equipped with an RJ45 communication port.

Main functions

Functions like real-time monitoring of system data, browsing and modifying related parameters, and restoring factory defaults are based on the LCD and functional key operation.

parts inside the controller. Do not disassemble or attempt to repair it.





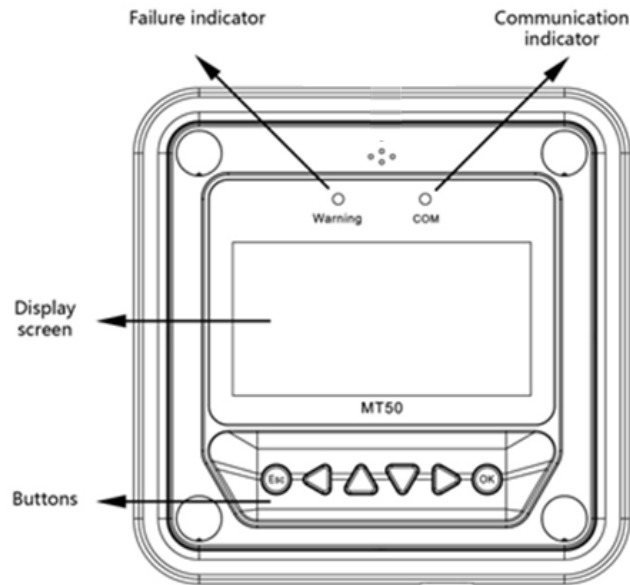



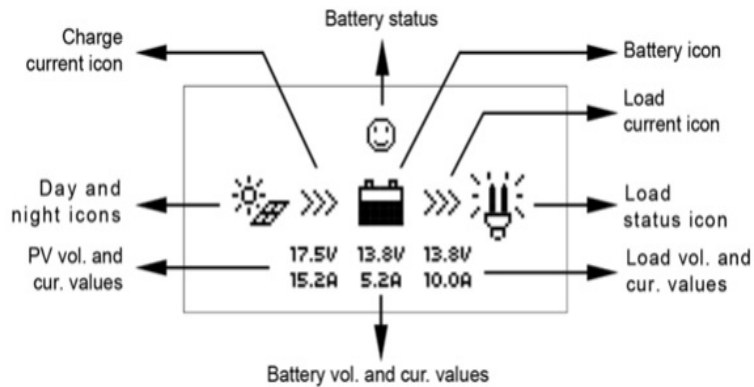

Product Features

Front view



Module	Func on
Failure indicator	Failure indicator flashes in case of failure of the connected devices. For failure informa on, please check the Solar Controller Manual.
Communica on indicator	Indicate communica on status when the display is connected with the controller.
Display screen	Man-machine interac on opera on interface. Note: The display screen can be viewed clearly when the angle between the end-user's horizontal sight and the display screen is within 90°. If the angle exceeds 90°, the informa on on the display screen cannot be viewed clearly.
Bu ons	The Meter bu ons include four naviga on bu ons and two opera onal bu ons. See the specific direc ons in the Opera onal Manual.
RJ45 interface	Connect with the controller; it is used for communica on and power supply.



Name	LCD Display	Instruction
Day and night icons		Night
		Day Note: The threshold voltage is 1V. When it goes higher than 1V, it is daytime.
Charge current icon		The icon is dynamically running if there is a charge current.
Battery icon		The battery capacity is dynamically displayed. Note: When the battery is over-discharged, this icon is displayed as " 
Battery status icons		Normal voltage
		Under voltage
		Over-discharge
Load current icon		The icon is dynamically running if there is a discharge current.
Load status icon		Load On
		Load Off Note: In the Manual Mode, pressing the "OK" button to switch on/off the load.
PV vol. and cur. values	17.5V 15.2A	Display the PV voltage and current values.
Battery vol. and cur. values	13.8V 5.2A	Display the battery voltage and current values.
Load vol. and cur. values	13.8V 10.0A	Display the load voltage and current values.





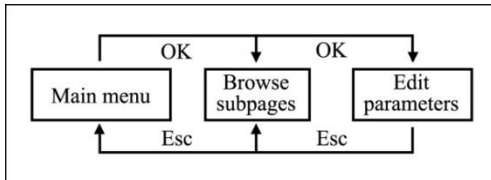

Operation

Buttons



The buttons are respectively (from left to right) "ESC," "Left," "Up," "Down," "Right," and "OK "buttons. The operation is described in the schematic operation diagram below:



The default entry page is the browse mode. Press the  button and input the correct password to enter the modification mode.  and  buttons could be used to move the cursor.  and  buttons could be used to modify the parameter values when the cursor is located at the current place.  and  buttons could be finally used to confirm and cancel the modification of the control parameters.



Main menu

Enter the Main Menu by pressing "Esc." The "Up" and "Down" buttons are respectively used to move the cursor to select the menu items, "OK," and "ESC" buttons are respectively used to enter or exit the corresponding pages of the menu items.

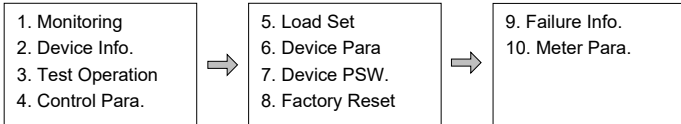

Real-time monitoring

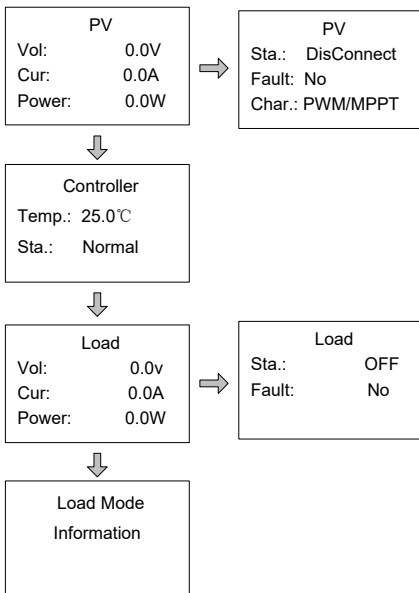
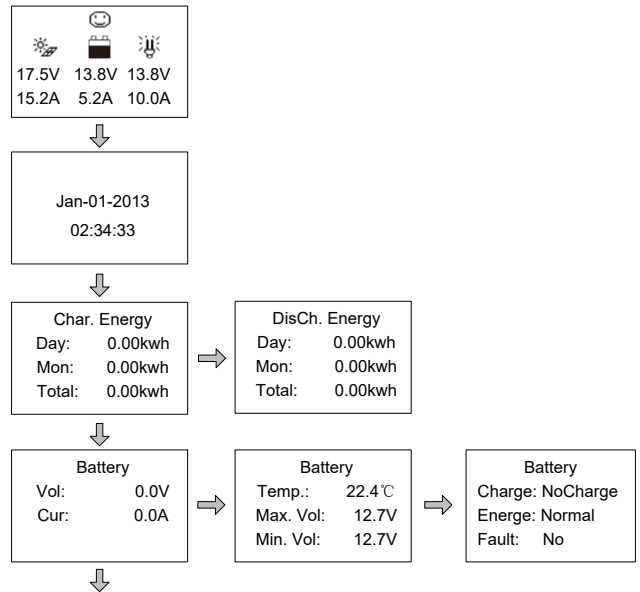



Operational tips: Move between rows by pressing the or buttons. Move along a row by pressing the or buttons.

Device information

The controllers' parameters are displayed below:





Rate.Vol:	12V
Char.Cur:	10.0A
Disc.Cur:	2.6A

Operational tips:  and  buttons are respectively used to turn the browse page upward and downward.

Test operation

Load switch test operation is conducted on the connection solar controller to see if the load output is normal. The test operation does not affect the working settings under actual load, which means that the solar controller will exit from the test mode when exiting the Test Operation page.

Test Operation	
LS****B:	OFF

Operational tips: Enter the page and input the correct password; use  and  buttons to modify the On/Off status. Press  to confirm and press  to cancel the test operation.

Control parameter

Browse and modification operations are conducted over the control parameters of the solar controller. See the scope of parameter modification in the control parameters table and the page of control parameters in the diagram below:

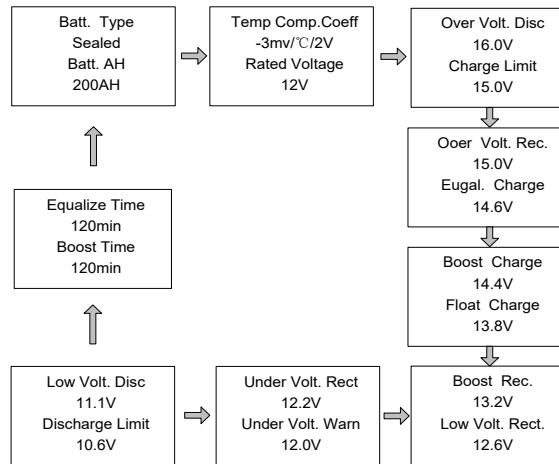

Please refer to this user guide or contact sales for the details of setting operations.

Program Setting

There are four available, customisable programs (Manual, Light on/off, Light on + timer, Time control)

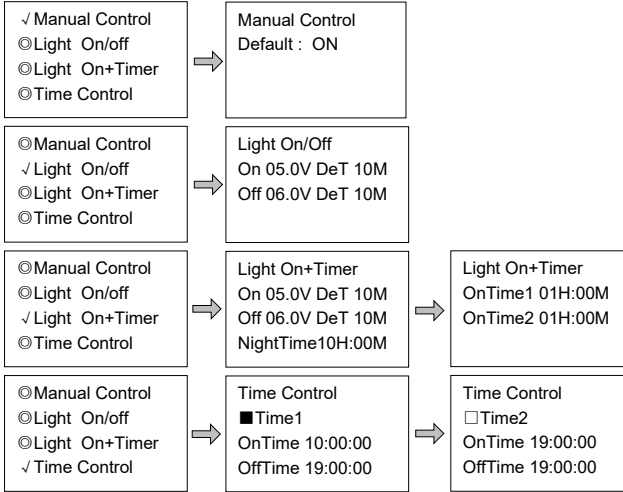

Manual control

Mode	Introductions
ON	The load is on if the battery capacity is enough and no abnormal conditions happen.
OFF	The load is off all the time.

Light On/Off

Light On voltage(Night threshold)	The load output is automatically turned on when the bellows occur at the same time: <ol style="list-style-type: none"> The solar module's input voltage is lower than the Light On voltage. The battery capacity is enough. No abnormal conditions happen.
Light Off voltage(Day threshold)	When the solar module's input voltage is higher than the Light Off voltage, the load output is automatically turned off.
Delaytime	It means the confirmation time for the light signal. During this period, if the light signal voltage continues matching the Light On/Off voltage, the controller will perform corresponding actions (the time adjustment range: 0~99mins).

Light On+ timer

Working time 1 (T1)	Load working period after light control turns on the load	Any working time is set as "0"; it means this time will stop working. The real working time of T2 depends on the night-time and the length of T1, T2.
Working time 2 (T2)	Load working period before light control turns off the load	
Night-time	Total night-time controller get from calculation(≥3h)	

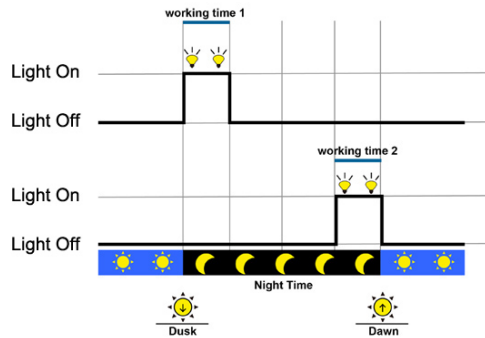



Time control

Workingtime1 (T1)	Control on/off time of the load through real-time clock mode.	Working time 1 is the compulsory load working time interval. Working time 2 is optional.
Workingtime2 (T2)	Realize the dual timer function of the load control through real-time clock mode.	

Device parameter

The solar controller's software version could be checked via the device parameter page. And device data like device ID, device LCD backlight time, and device clock could also be checked and modified. The device parameter page shows in the diagram below:

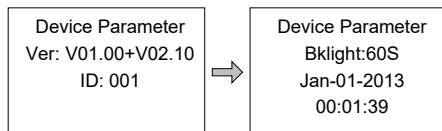

Note: the bigger the connection device's ID value, the longer the communication identification interval will be (the maximum interval<6 minutes).

Type	Notes
Ver	It indicates the Solar controller's software and hardware version numbers.
ID	It indicates the Solar controller's communication ID numbers.
Bklight	It indicates the Solar controller's LCD backlight time.
Month-Day-Year H: M: S	It indicates the Solar controller's internal clock.

Device password

The solar controller's password could be modified via the device password page. The device password is a 6-digit figure which is required before entering the modification mode of "Control parameter," "Load setting," "Device parameter," "Device password," "Factory reset" pages. The page of the device password in the diagram shows as below:

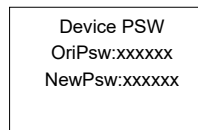

Note: The default password of the solar charge controller is "000000". Factory reset.

The solar charger controller's default parameters could be restored via the Factory reset page. Including the "Control parameter," "Load setting," "Charge mode," and "Device password" could all be restored to the factory defaults (the factory default password of the devices is "000000").

Failure information

The solar controller's failure information could be checked via the Failure information page (a maximum of 15 failure messages could be displayed). After the solar controller's failures are eliminated, the corresponding failure information will also be automatically eliminated.







Common failure information

Failure type	LCD display	Instructions
Charging device status	Load MOS-Short	The MOSFET of the load driver is short-circuited.
	Load Circuit	The load circuit is short-circuited.
	Load O. cur.	The load circuit is over current.
	Input O. cur.	The PV input current exceeds the rated current.
	RPP Short	The MOSFET of the reverse polarity protection (RPP) is short-circuited.
	RPP Break	The MOSFET of the reverse polarity protection (RPP) breaks.
	Char. MOS-Short	The MOSFET of the charge driver is short-circuited.
	No Input Power	The input power is not connected successfully.
	Input vol. High	The input voltage is very high.
Input vol. Low	The input voltage is very low.	
Controller status	Ctrlr O. Temp.	The controller is over-temperature.
Communication status	Comm. Timeout	The communication is timeout.
Battery Status	Batt. O. Hi. Temp.	The battery is over high temperature.
	Batt. O. Lo. Temp.	The battery is over low temperature.
	Batt. I. R. Eorr	The internal resistance of the battery is in error.
	Rated Vol Err.	The rated voltage is in error.
	Batt. OVD	The battery voltage exceeds the over voltage disconnect (OVD) voltage value.
	Batt. UVW	The battery voltage is lower than the under voltage warning (UVW) voltage value.
	Batt. LVD	The battery voltage is lower than the low voltage disconnect (LVD) voltage value.
	Batt. Err	The battery type is in error.

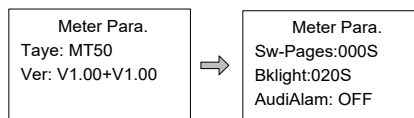
Meter parameter

The meter's model, software, and hardware version could be checked via the meter parameter page. And the two parameters (Switch pages, Backlight) could be browsed and modified as well.



On the above anyone page, long-press  +  +  +  at the same time to enter the language selection page:

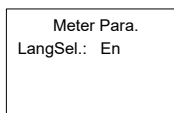

Parameters	Default	Range	Remark
Sw-Pages	0	0~120S	The automatic switchover inverter for real-time monitoring page
BKlight	20	0~999S	LCD backlight time
LangSel.	Cn	Cn/En	Switch the page display language between Chinese and English.

Technical Specifications

Electrical Parameter	
Self-consumption	Backlight ON<23mA
	Backlight OFF<15mA
Mechanical Parameter	
Faceplate dimensions	98×98 mm
Frame dimensions	114×114 mm
Connector type	RJ45
Cable length (m)	Standard: 2m, Longest: 50 m
Net weight	Simple package: 0.23 Kg Standard package: 0.32kg
Environmental Parameter	
Environment temperature	-20°C~+70°C